

## ZERO 100

### Midrange specifications:

Name		<b>HG-100Z</b>
DC resistance	Rdc	<b>2,5 Ω</b>
Nominal impedance	ZN	<b>3 Ω</b>
Resonance frequency	fs	<b>106,0 HZ</b>
Voice coil diameter		<b>25 mm</b>
Mechanical Q factor	Qms	<b>3,14</b>
Electrical Q factor	Qes	<b>0,78</b>
Total Q factor	Qts	<b>0,63</b>
Moving mass Mms		<b>5,83 g</b>
Effective piston area	Sd	<b>79 cm<sup>2</sup></b>
Mechanical resistance	Rms	<b>1,24 Kg/s</b>
Compliance	Cms	<b>0,39 mm/N</b>
Force factor	BL	<b>3,45 Tm</b>
Equivalent air volume	Vas	<b>3,39 dm<sup>3</sup></b>
Efficiency	η	<b>0,50 %</b>
SPL 2,83V/1m		<b>94,2 dB</b>

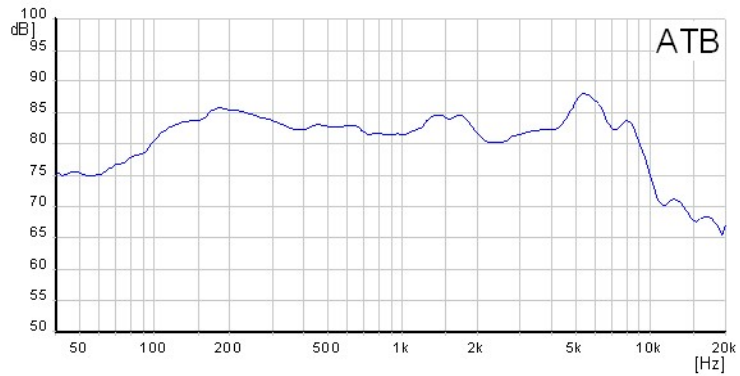

Cone: **Paper**  
 Spider: **Nomex**  
 Surround: **Rubber**  
 Coil former: **Aluminum**  
 Basket: **Steel**  
 Dust cap: **Silk**

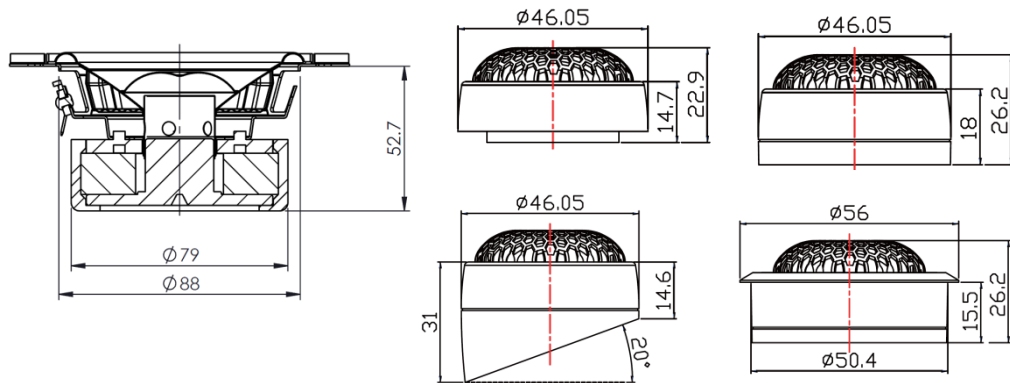

### Tweeter specifications:

Name		<b>HG-25SG</b>
DC resistance	Rdc	<b>3,3 Ω</b>
Nominal impedance	ZN	<b>4 Ω</b>
Resonance frequency	fs	<b>1580 HZ</b>
Voice coil diameter		<b>25 mm</b>

